



QSE **essentials**



QSE essentials

ABOUT COLLINS

Heritage : noun - 1. denoting a traditional brand or product regarded as emblematic of fine craftsmanship, 2. property that is or may be inherited; an inheritance.

Since the Swann family took ownership of the business in 1983 with two employees and about as many customers, Collins Manufacturing Company has grown to be the largest domestic manufacturer of beauty and barber furniture and equipment. Steeped in HERITAGE, Collins equipment is PROUDLY HANDCRAFTED IN TENNESSEE by a multi-generational workforce of craftsmen and -women under the leadership of the second generation of the Swann family. Dedicated to the beauty industry, Collins' equipment is designed and manufactured with a blend of ergonomics, function, and style providing stylists and barbers with high-quality, yet affordable, equipment for their daily use.

Along with our own Collins brand of beauty and barber equipment and furnishings, Collins also manufactures and distributes two more historic beauty equipment brands, **Jeffco** (acquired in 2010) and **VEECO** (acquired in 2019). Founded in 1965 and 1942, respectively, both Jeffco and Veeco have deep roots in the beauty industry and build upon Collins HERITAGE.

OUR MISSION

To equip and support beauty industry professionals for success through stylish and reliable furnishings.

*for more from Collins
visit www.collins.co*

Collins' ESSENTIAL Quick Salon Equipment product line has been designed to provide salon and barbershop owners the ESSENTIAL furniture and equipment they need to open their own business - both quickly and affordably. Quality, function, and style have not been ignored during the design process - with each piece providing all of the features needed to help you and your employees provide professional services and create a noteworthy experience for your clients. With a minimum of a 5-year warranty on salon chair hydraulic bases and HPL clad 1 1/4" countertops on all of the cabinetry, the Essentials equipment line is built to last.

In an effort to reduce cost and delivery time, Essentials color selections have been simplified to three popular upholstery colors and 6 neutral cabinetry color choices. For an upcharge, these items can be made in hundreds of other color options. If you can't find a product to fit your specific needs in our Essentials product line, Collins is certain to have something for you in our other offerings - or you can have one of our designers create a custom piece just for you! With direct-to-salon sales representatives located around the country, a fully functioning e-commerce website, and many traditional brick-and-mortar and web-based beauty dealers, you can buy Collins through many different channels.



CONTACT COLLINS

Collins Manufacturing Company
2000 Bowser Rd.
Cookeville, TN 38506
Sales: 855.479.9600
Distributors: 800.292.6450
sales@collins.co
Technical Support:
Toll-free: 855.757.6877
Email: techsupport@collins.co
*On-site diagnosis and repair
is not available.*



TABLE OF CONTENTS

- salon seating.....4-9
- color selections.....10
- portable stations.....11
- styling stations.....12-13
- tower stations.....14-15
- stations w/ retail.....16-17
- mirrors.....18-19
- formula stations.....20-21
- wet stations.....22-23
- shampoo.....24-27
- modular storage/dispensary.....28-31
- reception area.....32-35
- manicure/pedicure.....36-37
- men's grooming.....38-39
- shampoo bowls/parts.....40
- dryers/processors.....41
- bases/footrests.....42
- mats/warranty.....43



BRIXEN

Chair Family

E200-4250DS BRIXEN HYDRAULIC STYLING CHAIR
PICTURED WITH OPTIONAL T-BAR FOOTREST
27.5"W x 33"D x 34"H

SEE PAGE 42 FOR ALL HYDRAULIC BASE OPTIONS



E210-4250 BRIXEN HYDRAULIC ALL-PURPOSE CHAIR
27.5"W x 33"D x 34"H



E220D BRIXEN DRYER CHAIR W/ SOL-AIR DRYER
27.5"W x 32"D x 48"H



E230L BRIXEN LEVER CONTROL SHAMPOO CHAIR
27.5"W x 25"D x 29"H



E240 BRIXEN TASK-CLIENT CHAIR
27.5"W x 25"D x 31"H



E250L BRIXEN LEVER CONTROL KICKOUT FOOTREST
SHAMPOO CHAIR. 27.5"W x 27"D x 32"H



E2-BWS BRIXEN BACKWASH SHUTTLE W/ CB86 TILTING BOWL
27.5"W x 48"D x 40"H



E2-AOS BRIXEN ADD-ON SHUTTLE W/CB82 TILTING BOWL
27.5"W x 50"D x 40"H



E2-J-BWS BRIXEN POLISHED STAINLESS
BACKWASH SHUTTLE W/ CB85 TILTING BOWL
27.5"W x 48"D x 40"H



E2-V-BWS BRIXEN BRUSHED STAINLESS
BACKWASH SHUTTLE W/ CB85 TILTING BOWL
27.5"W x 48"D x 39"H

Upholstery Selections



FLAT BLACK SADDLE CHAMPAGNE

The Brixen chair family embodies everything coveted in a premium salon chair. From the upholstered arms that suspend the floating back cushion with built-in lumbar support - to the full twenty-one inches of clearance between the arms, the Brixen chair sets the stage for a memorable client experience while also providing the stylist with all the features desired.



LILA

Chair Family



E300-3250 LILA HYDRAULIC STYLING CHAIR
24.5"W x 35"D x 34"H



E310-4250DD LILA HYDRAULIC ALL-PURPOSE CHAIR
PICTURED WITH OPTIONAL T-BAR FOOTREST
24.5"W x 35"D x 34"H



E320D LILA DRYER CHAIR W/ SOL-AIR DRYER
24.5"W x 32"D x 48"H



E330L LILA LEVER CONTROL SHAMPOO CHAIR
24.5"W x 26.5"D x 29"H



E340 LILA TASK-CLIENT CHAIR
24.5"W x 26.5"D x 31"H



E350L LILA LEVER CONTROL KICKOUT FOOTREST
SHAMPOO CHAIR. 24.5"W x 27"D x 32"H



E3-BWS LILA BACKWASH SHUTTLE W/ CB86 TILTING BOWL
24.5"W x 48"D x 40"H



E3-AOS LILA ADD-ON SHUTTLE W/CB82 TILTING BOWL
24.5"W x 50"D x 40"H



E3-J-BWS LILA POLISHED STAINLESS
BACKWASH SHUTTLE W/ CB85 TILTING BOWL
24.5"W x 48"D x 40"H



E3-V-BWS LILA BRUSHED STAINLESS
BACKWASH SHUTTLE W/ CB85 TILTING BOWL
24.5"W x 48"D x 39"H

Upholstery Selections



FLAT BLACK SADDLE CHAMPAGNE

The polished chrome arms and tapered cushions distinguish the Lila chair family from others. Modern, yet classic, the Lila's size and design jibes with an urban salon setting thanks to its clean lines and elegant look. Even with the Lila's smaller footprint, which fits tighter salon spaces nicely, twenty and one-half inches of clearance between the arms still provides adequate space for most clients.



MERANO

Chair Family



E100-4250DD MERANO HYDRAULIC STYLING CHAIR
26"W x 34.5"D x 33.5"H

SEE PAGE 42 FOR ALL HYDRAULIC BASE OPTIONS



E110-4250 MERANO HYDRAULIC ALL-PURPOSE CHAIR
PICTURED WITH OPTIONAL T-BAR FOOTREST
26"W x 34.5"D x 33.5"H



E120D MERANO DRYER CHAIR W/ SOL-AIR DRYER
26"W x 32"D x 48"H



E130L MERANO LEVER CONTROL SHAMPOO CHAIR
26"W x 26"D x 28.5"H



E140 MERANO TASK-CLIENT CHAIR
26"W x 26"D x 30.5"H



E150L MERANO LEVER CONTROL KICKOUT
FOOTREST SHAMPOO CHAIR. 26"W x 27"D x 32"H



E1-BWS MERANO BACKWASH SHUTTLE W/ CB86 TILTING BOWL
26"W x 48"D x 40"H



E1-AOS MERANO ADD-ON SHUTTLE W/CB82 TILTING BOWL
26"W x 50"D x 40"H



E1-J-BWS MERANO POLISHED STAINLESS
BACKWASH SHUTTLE W/ CB85 TILTING BOWL
26"W x 48"D x 40"H



E1-V-BWS MERANO BRUSHED STAINLESS
BACKWASH SHUTTLE W/ CB85 TILTING BOWL
26"W x 48"D x 39"H

Upholstery Selections



FLAT BLACK SADDLE CHAMPAGNE

Simple, yet elegant, the Merano chair family is the most utilitarian seating option in the Essentials chair lineup. With twenty-two inches between the stylish, long-lasting urethane arms, the Merano chair is sure to fit every client with ease. With the overall design modeled after one of Collins' most comfortable and best-selling salon chairs, client comfort is almost guaranteed.

essentials styling stations



- 1 Choose the station that fits your needs and style.
- 2 Choose your station color
- 3 Choose your pull color
- 4 Add a mirror

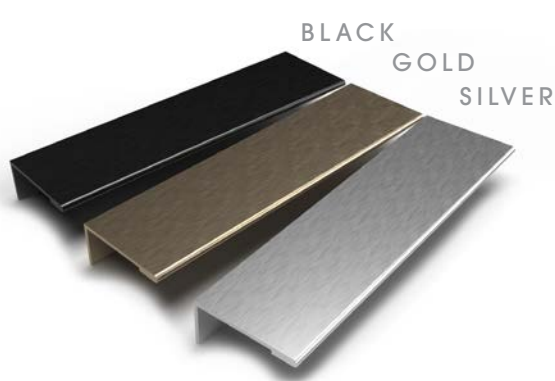

BELAIR TIMBERGRAIN **MONTEVERDI** TIMBERGRAIN **GREAT BEAR** TIMBERGRAIN
FAIRCHILD TIMBERGRAIN **BLACK** GLOSSLINE **LINEN**

COLLINS ALL NEW TFL (THERMALLY FUSED LAMINATE) COLOR SELECTIONS

*PREMIUM TIMBERGRAIN - LOW-SHEEN WOOD FINISH WITH A DIMENSIONAL, REALISTIC TICKING AND NATURAL VARIATION ACROSS THE SURFACE, MUCH LIKE NATURAL VENEER

PORTABLES

Nico



E1001 FINLEY PORTABLE STATION W/ TWIN WHEEL CASTERS & STAINLESS STEEL TOOL PANEL. 15+6"W x 15.5"D x 39"H



E1003 NICO PORTABLE STATION W/ INDUSTRIAL CASTERS, TIP-OUT TOOL PANEL & SIX OUTLET POWER STRIP. 16"W x 15.5"D x 42"H

Finley



E1001P FINLEY PORTABLE STATION W/ TWIN WHEEL CASTERS, STAINLESS STEEL TOOL PANEL & SIX OUTLET POWER STRIP. 15+6"W x 15.5"D x 39"H



E1008 LF PORTABLE STATION W/ INDUSTRIAL CASTERS & STAINLESS STEEL TOP TOOL PANEL. 18"W x 18"D x 41"H



E1003 NICO PORTABLE STYLING STATION. PICTURED WITH THE M08 ZADA LED MIRROR IN METAL FRAME

STYLING STATIONS



Finley

E1011 FINLEY STYLING STATION W/ STAINLESS STEEL TOOL PANEL. 15+6"W x 15.5"D x 39"H

E1011P FINLEY STYLING STATION W/ STAINLESS STEEL TOOL PANEL & SIX OUTLET POWER STRIP. 15+6"W x 15.5"D x 39"H

Aspen



E1012 ASPEN FLOATING STYLING STATION W/ TOOL PANEL DRAWER & SIX OUTLET POWER STRIP. 18"W x 15.5"D x 33"H

E1012P ASPEN STYLING STATION W/ TOOL PANEL DRAWER, SIX OUTLET POWER STRIP & METAL LEGS. 18"W x 15.5"D x 39"H



E1012P ASPEN STYLING STATION WITH METAL LEGS. PICTURED WITH THE M02L ARCHED MIRROR WITH LEDGE



E1013P NICO STYLING STATION WITH METAL ACCENT TOE-KICK. PICTURED WITH THE M01-24X72 MIRROR

Choose from our Finley, Aspen or Nico cabinet configurations, pick your laminate, pull and accent colors and then set it off with the perfect mirror to compliment your space (ordered separately on pages 18-19).



E1013 NICO STYLING STATION W/ TIP-OUT TOOL PANEL & SIX OUTLET POWER STRIP. 16"W x 15.5"D x 42"H



E1013P NICO STYLING STATION W/ TIP-OUT TOOL PANEL, SIX OUTLET POWER STRIP & LAMINATED METAL ACCENT TOE-KICK. 16"W x 15.5"D x 42"H

Nico



STYLING TOWERS



Aspen Floating Tower



E1022P ASPEN STYLING TOWER W/ LEGS. PICTURED WITH THE M07-28X68 MIRROR



E1021P FINLEY STYLING TOWER W/ POWER STRIP. PICTURED WITH THE M01-24X72 MIRROR

Choose from our Finley, Aspen or Nico cabinet configurations, pick your laminate, pull and accent colors and then set it off with the perfect mirror to compliment your space (ordered separately on pages 18-19).



Finley

E1021 FINLEY STYLING TOWER W/ STAINLESS STEEL TOOL PANEL & UPPER STORAGE. 15+6"W x 15.5"D x 78"H



E1021P FINLEY STYLING TOWER W/ STAINLESS STEEL TOOL PANEL, UPPER STORAGE & SIX OUTLET POWER STRIP. 15+6"W x 15.5"D x 78"H



Nico

E1023P NICO STYLING TOWER W/ TIP-OUT TOOL PANEL, SIX OUTLET POWER STRIP, UPPER STORAGE & LAMINATED METAL ACCENT TOE-KICK. 16"W x 15.5"D x 78"H



Aspen

E1022 ASPEN FLOATING STYLING TOWER W/ TOOL PANEL DRAWER, UPPER STORAGE & SIX OUTLET POWER STRIP. 18"W x 15.5"D x 72"H



E1022P ASPEN STYLING TOWER W/ TOOL PANEL DRAWER, UPPER STORAGE, METAL LEGS & SIX OUTLET POWER STRIP. 18"W x 15.5"D x 78"H



E1023 NICO STYLING TOWER W/ TIP-OUT TOOL PANEL, SIX OUTLET POWER STRIP & UPPER STORAGE. 16"W x 15.5"D x 78"H





STYLING STATIONS WITH RETAIL



E1032P-R2 ASPEN STYLING TOWER W/ R2 RETAIL.

Choose Your Retail Style

Choose from our Finley, Aspen or Nico cabinet configurations, choose a retail option, pick your laminate, pull and accent colors and then set it off with the perfect mirror to compliment your space (ordered separately on pages 18-19).



R1 FRAMED STYLING STATION RETAIL 15-18"W x 6"D x 39"H



R2 FLOATING STYLING STATION RETAIL 15-18"W x 8"D x 2"H



R3 FLOATING STYLING STATION RETAIL ON PANEL 15-18"W x 6"D x 39"H



Aspen

E1033P-R2 NICO STYLING TOWER W/ RETAIL, TIP-OUT TOOL PANEL, SIX OUTLET POWER STRIP & LAMINATED METAL ACCENT TOE-KICK. 16"W x 15.5"D x 81"H

E1032-R3 ASPEN FLOATING STYLING TOWER W/ RETAIL, TOOL PANEL DRAWER & SIX OUTLET POWER STRIP. 18"W x 15.5"D x 72"H

E1032P-R3 ASPEN STYLING TOWER W/ RETAIL, TOOL PANEL DRAWER, METAL LEGS & SIX OUTLET POWER STRIP. 18"W x 15.5"D x 78"H



Nico

Finley

E1033-R1 NICO STYLING TOWER W/ RETAIL, TIP-OUT TOOL PANEL & SIX OUTLET POWER STRIP. 16"W x 15.5"D x 81"H

E1031-R1 FINLEY STYLING TOWER W/ RETAIL & STAINLESS STEEL TOOL PANEL. 15+6"W x 15.5"D x 78"H

E1031P-R1 FINLEY STYLING TOWER W/ RETAIL, STAINLESS STEEL TOOL PANEL & SIX OUTLET POWER STRIP. 15+6"W x 15.5"D x 78"H

MIRRORS



M01-24X72 RECTANGULAR MIRROR WITH METAL FRAME 24"W x 1.5"D x 72"H



M01-30X48 RECTANGULAR MIRROR WITH METAL FRAME 30"W x 1.5"D x 48"H



M02 ARCHED MIRROR W/ LAMINATED EDGE BACK PANEL 30"W x 1"D x 64"H



M02L ARCHED MIRROR W/ LAMINATED LEDGE & EDGE BACK PANEL 30"W x 7"D x 64"H



M03 INDIE MIRROR W/ LAMINATED EDGE BACK PANEL 30"W x 1"D x 64"H



M03L INDIE MIRROR LAMINATED LEDGE & EDGE BACK PANEL 30"W x 7"D x 64"H

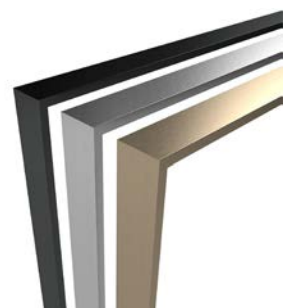

ALL METAL MIRRORS ARE AVAILABLE IN GOLD, SILVER OR BLACK.



M04 FLOATING ROUND MIRROR 36"W x 1"D x 36"H



M04LED LED BACK-LIT FLOATING ROUND MIRROR 36"W x 2"D x 36"H

SPECIFY IF LED MIRRORS WILL BE HARD WIRED OR SUPPLIED WITH OUTLET PLUG

Mirrors for Any Style



M05-30X48 FLOATING RECTANGULAR MIRROR 30"W x 1"D x 48"H



M07-30X48 LED ROOTS MIRROR IN METAL FRAME 30"W x 1.5"D x 48"H



M05-36X36 FLOATING SQUARE MIRROR 36"W x 1"D x 36"H



M05LED-30X48 LED BACKLIT FLOATING RECTANGULAR MIRROR 30"W x 2"D x 48"H



M07-28X68 LED ROOTS MIRROR IN METAL FRAME 28"W x 1.5"D x 68"H



M05LED-36X36 LED BACK-LIT FLOATING SQUARE MIRROR 36"W x 2"D x 36"H



M06 LED ROOTS MIRROR W/ LEDGE AND BAG HOOK 30"W x 7"D x 78"H



M08 LED ZADA MIRROR IN METAL FRAME 28"W x 1.5"D x 68"H

FORMULA STATIONS



Versatile Work Space

E1041 ESSENTIALS FORMULA TOWER PICTURED WITH THE M01-24X72 MIRROR 15"W x 14.5"D x 76"H



E1041 ESSENTIALS FORMULA TOWER PICTURED WITH THE M02L MIRROR 15"W x 14.5"D x 76"H



Extra Storage

E1042 ESSENTIALS FORMULA WALL STATION PICTURED WITH THE M08 MIRROR 30"W x 15.5"D x 76"H



ESSENTIALS FORMULA STATIONS ARE AVAILABLE AS A TOWER (FRONT FACING), WALL STATION WITH EXTRA STORAGE AND ISLAND FOR TWO STYLISTS. THESE ARE SOME POSSIBLE CONFIGURATIONS. MORE MIRROR CHOICES ARE ARE PAGES 18-19. (MIRRORS ARE ORDERED SEPARATELY)

ALL ESSENTIALS FORMULA STATIONS ARE EQUIPPED WITH TOOL PANELS, SIX OUTLET POWER STRIP, TWO DRAWERS AND AN ADJUSTABLE SHELF PER STYLIST. THE E1042 FORMULA WALL STATION HAS EXTRA STORAGE WITH TWO DOORS AND FOUR MORE ADJUSTABLE SHELVES.

Choose from our formula tower, wall station or island station options, pick your laminate, pull and accent colors and then set it off with the perfect mirror to compliment your space (ordered separately on pages 18-19).



Maximize floor Space



E1043 ESSENTIALS FORMULA ISLAND STATION PICTURED WITH THE M07-28X68 MIRROR 30"W x 15"D x 76"H



E1043 ESSENTIALS FORMULA ISLAND STATION PICTURED WITH THE M04 MIRROR (BACKLIT LED MIRRORS ARE NOT RECOMMEND FOR ISLAND STATIONS) 30"W x 15"D x 76"H



E1043 ESSENTIALS FORMULA ISLAND STATION PICTURED WITH THE M03 MIRROR 30"W x 15"D x 76"H

WET STATIONS



E1051 FINLEY WET STATION W/ STAINLESS STEEL TOOL PANEL, DOOR W/ ADJUSTABLE SHELF AND MOLDED BOTTLE WELL. 39+6"W x 15.5"D x 39"H



E1051P FINLEY WET STATION W/ STAINLESS STEEL TOOL PANEL, DOOR W/ ADJUSTABLE SHELF, MOLDED BOTTLE WELL AND SIX OUTLET POWER STRIP. 39+6"W x 15.5"D x 39"H



E1061 FINLEY WIDE WET STATION W/ STAINLESS STEEL TOOL PANEL, DOORS W/ ADJUSTABLE SHELVES, AND MOLDED BOTTLE WELL. 54+6"W x 15.5"D x 39"H



E1061P FINLEY WIDE WET STATION W/ STAINLESS STEEL TOOL PANEL, DOORS W/ ADJUSTABLE SHELVES, MOLDED BOTTLE WELL AND SIX OUTLET POWER STRIP. 54+6"W x 15.5"D x 39"H



E1053 NICO WET STATION W/ TIP-OUT TOOL PANEL, SIX OUTLET POWER STRIP AND MOLDED BOTTLE WELL. 39.625"W x 15.5"D x 42"H

Nico



E1053P NICO WET STATION W/ RETAIL, TIP-OUT TOOL PANEL, SIX OUTLET POWER STRIP, LAMINATED METAL ACCENT TOE-KICK AND MOLDED BOTTLE WELL. 39.625"W x 15.5"D x 42"H



E1063 NICO WIDE WET STATION W/ TIP-OUT TOOL PANEL, SIX OUTLET POWER STRIP, DOOR W/ ADJUSTABLE SHELF AND MOLDED BOTTLE WELL. 55.5"W x 15.5"D x 42"H

Nico



E1063P NICO WIDE WET STATION, TIP-OUT TOOL PANEL, SIX OUTLET POWER STRIP, LAMINATED METAL ACCENT TOE-KICK, DOOR W/ ADJUSTABLE SHELF AND MOLDED BOTTLE WELL. 55.5"W x 15.5"D x 42"H



E1052 ASPEN FLOATING WET STATION W/ TOOL PANEL DRAWER, SIX OUTLET POWER STRIP AND MOLDED BOTTLE WELL. 41.5"W x 15.5"D x 33"H



E1052P ASPEN WET STATION W/ TOOL PANEL DRAWER, METAL LEGS, SIX OUTLET POWER STRIP, DOOR W/ ADJUSTABLE SHELF AND MOLDED BOTTLE WELL. 41.5"W x 15.5"D x 39"H

Aspen



E1062 ASPEN FLOATING WET STATION W/ TOOL PANEL DRAWER, SIX OUTLET POWER STRIP, DOOR WITH ADJUSTABLE SHELF AND MOLDED BOTTLE WELL. 60"W x 15.5"D x 33"H



E1062P ASPEN WET STATION W/ TOOL PANEL DRAWER, METAL LEGS, SIX OUTLET POWER STRIP, DOOR WITH ADJUSTABLE SHELF AND MOLDED BOTTLE WELL. 60"W x 15.5"D x 39"H

Choose from our Finley, Aspen or Nico cabinet configurations, pick your laminate, pull and accent colors choose a bowl (ordered separately on page 40), and then set it off with the perfect mirror to compliment your space (ordered separately on pages 18-19). All wet stations pictured with CB23

SHAMPOO



E1101-24 24" W ESSENTIALS BULKHEAD W/ TWO UPPER DOORS. 24"W x 12"D x 81"H PICTURED WITH CB19 BOWL.



E1101-48 48"W ESSENTIALS BULKHEAD W/ THREE UPPER DOORS AND TIP-OUT SOILED TOWEL BIN. BOWL 48"W x 12"D x 81"H PICTURED WITH CB19.

E1101-42 42"W & **E1101-45** 45"W VERSIONS ALSO AVAILABLE



E1102-48 48"W PREMIUM ESSENTIALS BULKHEAD W/ THREE UPPER DOORS, MOLDED BOTTLE WELL AND FLIPPER DOOR ACCESS TO SOILED TOWEL BIN. 48"W x 12"D x 81"H PICTURED WITH CB19 BOWL.

E1102-45 45"W VERSION ALSO AVAILABLE

E1102-48 PREMIUM ESSENTIALS BULKHEAD W/ BRIXEN **E2-AOS**

WHEN PURCHASED W/ AOS (ADD-ON SHUTTLE) BULKHEADS COME WITH PRE-CUT PLUMBING ACCESS.



E1103-32 ASPEN FLOATING BACKBAR W/ UPPER AND LOWER STORAGE INCLUDING A SOILED TOWEL BIN IN LOWER RIGHT. 32"W x 15"D x 75"H



E1103-48 ASPEN FLOATING BACKBAR W/ UPPER AND LOWER STORAGE INCLUDING A SOILED TOWEL BIN IN LOWER RIGHT. 48"W x 15"D x 75"H



E1103P-48 ASPEN BACKBAR W/ METAL LEGS, UPPER AND LOWER STORAGE INCLUDING A SOILED TOWEL BIN IN LOWER RIGHT. 48"W x 15"D x 81"H

E1103P-32 ASPEN BACKBAR W/ METAL LEGS, UPPER AND LOWER STORAGE INCLUDING A SOILED TOWEL BIN IN LOWER RIGHT. 32"W x 15"D x 81"H

Nico



E1104-32 NICO BACKBAR W/ UPPER AND LOWER STORAGE INCLUDING A SOILED TOWEL BIN IN LOWER RIGHT. 32"W x 15"D x 81"H



E1104P-32 NICO BACKBAR W/ METAL ACCENT TOE-KICK, UPPER AND LOWER STORAGE INCLUDING A SOILED TOWEL BIN IN LOWER RIGHT. 32"W x 15"D x 81"H



E1104P-48 NICO BACKBAR W/ METAL ACCENT TOE-KICK, UPPER AND LOWER STORAGE INCLUDING A SOILED TOWEL BIN IN LOWER RIGHT. 48"W x 15"D x 81"H



E1104-48 NICO BACKBAR W/ UPPER AND LOWER STORAGE INCLUDING A SOILED TOWEL BIN IN LOWER RIGHT. 48"W x 15"D x 81"H

SHAMPOO



E1106-48 TWO E1106-16 SHAMPOO PEDESTALS 16"X16"X23" FOR USE WITH TILT BOWL PLUS E1107 BOTTLE WELL. 48"W X 16"D X 25.5"H PICTURED WITH CB86



E1107-16 16" W ADD-ON CABINET W/ BOTTLE WELL & SOILED TOWEL BIN. 16"W X 16"D X 25.5"H



E1106-32 E1106-16 SHAMPOO PEDESTAL 16"X16"X23" FOR USE WITH TILT BOWL PLUS E1107-16 BOTTLE WELL. 32"W X 16"D X 25.5"H PICTURED WITH CB86



E1109-32 ASPEN BACKWASH 32"W W/ METAL LEGS. 32"W X 16"D X 23"H PICTURED WITH CB86

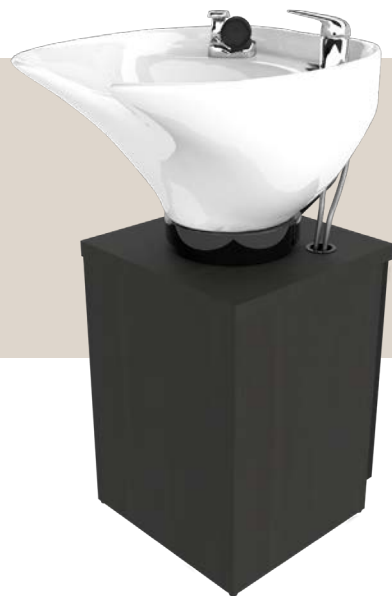

E1106-16 SHAMPOO PEDESTAL. FOR USE WITH TILT BOWL. 16"X16"X23" PICTURED WITH CB86 BOWL



E1108T-16 SHAMPOO PEDESTAL PLUMBED FROM BACK 16"W X 20"D X 25.5"H FOR USE WITH CB79 BOWL



E1106T-16 SHAMPOO PEDESTAL 16"X16"X25" FOR USE WITH CB79 BOWL



PICTURED E1101-48, E1108T-16, CB79 BOWL AND 2882 NIRVANA FIXED SHAMPOO CHAIR



2882 NIRVANA FIXED SHAMPOO CHAIR FOR USE WITH CB79 27"W x 36"D x 28.5"H

E271 OTTOMAN ON CASTERS 16"W x 16"D x 16"H



2850 VEECO TRANQUILITY SHAMPOO CHAIR W/ MOTORIZED FOOTREST. PICTURED WITH CB82 29"W x 48"D x 40"H



2851 VEECO TRANQUILITY SHAMPOO CHAIR W/ NO FOOTREST PICTURED WITH CB82 29"W x 48"D x 40"H



2861 VEECO SERENITY SHAMPOO CHAIR W/ NO FOOTREST PICTURED WITH CB86 29"W x 48"D x 40"H



2860 VEECO SERENITY SHAMPOO CHAIR W/ MOTORIZED FOOTREST PICTURED WITH CB86 29"W x 48"D x 40"H

Upholstery Selections



FLAT BLACK SADDLE CHAMPAGNE

MODULAR STORAGE & DISPENSARY

Build your perfect workspace



E1111 BASE CABINET W/ TWO DOORS & ADJUSTABLE SHELVES. 24"W x 20"D x 34.75"H



E1111P BASE CABINET W/ TWO DOORS, ADJUSTABLE SHELVES & LEGS. 24"W x 20"D x 34.75"H



E1112 BASE CABINET W/ TWO DOORS, ADJUSTABLE SHELVES & ONE DRAWER. 24"W x 20"D x 34.75"H



E1112P BASE CABINET W/ TWO DOORS, ADJUSTABLE SHELVES, ONE DRAWER & LEGS. 24"W x 20"D x 34.75"H



E1113 BASE CABINET W/ TWO DOORS, ADJUSTABLE SHELVES & SINK BASE. 24"W x 20"D x 34.75"H



E1113P BASE CABINET W/ TWO DOORS, ADJUSTABLE SHELVES, SINK BASE & LEGS. 24"W x 20"D x 34.75"H



E1114 24" BASE CABINET W/ FOUR DRAWERS. 24"W x 20"D x 34.75"H



E1114P 24" BASE CABINET W/ FOUR DRAWERS & LEGS. 24"W x 20"D x 34.75"H



E1115 24" OPEN BASE CABINET W/ TWO ADJUSTABLE SHELVES. 24"W x 20"D x 34.75"H



E1115P 24" OPEN BASE CABINET W/ TWO ADJUSTABLE SHELVES. 24"W x 20"D x 34.75"H



E1116 24" OPEN UPPER CABINET W/ TWO ADJUSTABLE SHELVES. 24"W x 12"D x 27"H



E1117 24" UPPER CABINET W/ TWO DOORS & ADJUSTABLE SHELVES. 24"W x 12"D x 27"H



E1138P-72 SEE PAGE 31 FOR CONFIGURATION DETAILS



E1118 UPPER CABINET W/ ACRYLIC COLOR CUBBIES. 24"W x 12"D x 27"H



E1119 UPPER STORAGE CABINET W/ ACRYLIC COLOR CUBBIES. 24"W x 12"D x 27"H

COUNTER TOPS
ALL 21"H X 1.25"D

E1120-24 24"

E1120-48 48"

E1120-72 72"



BACKSPLASHES
ALL 18"H X .75"D

E1121-24 24"W

E1121-48 48"W

E1121-72 72"W



E1128 SINK & FAUCET
18" OD SINK



E1122L (LEFT) OR **E1122R** (RIGHT) **E1122PL** (LEFT) OR **E1122PR** (RIGHT)

Tall cabinet split at 54". 12"W x 12"D x 81"H

All components ordered separately, including counter tops, backsplashes and sink. For pre-configured groupings see next page.

Popular Dispensary Configurations



E1131-24 E1113 LOWER CABINET AND E1119 W/ E1128 SINK, E1121-24 BACKSPLASH AND E1120-24 COUNTER TOP. 24.25"W x 21"D x 81"H



E1132-24 E1112 LOWER CABINET AND E1117 W/ E1121-24 BACKSPLASH AND E1120-24 COUNTER TOP. 24.25"W x 21"D x 81"H



E1134P-48 E1113P AND E1112P LOWER CABINETS & E1117 AND E1118 UPPER CABINETS W/ E1128 SINK, E1121-48 BACKSPLASH AND E1120-48 COUNTER TOP. 48.25"W x 21"D x 81"H



E1133-24 E1112 LOWER CABINET & E1116 UPPER CABINET W/ E1121-24 BACKSPLASH AND E1120-24 COUNTER TOP. 24.25"W x 21"D x 81"H



E1139-96 E1112, E1113 & E1114 LOWER CABINETS, THREE E1119 UPPER CABINETS, E1122L LEFT TALL CABINET, E1122R RIGHT TALL CABINET, E1128 SINK, E1121-72 BACKSPLASH AND E1120-72 COUNTER TOP. 96.25"W x 21"D x 81"H



E1135-48 E1113 AND E1112 LOWER CABINETS & TWO E1119 UPPER CABINETS W/ E1128 SINK, E1121-48 BACKSPLASH AND E1120-48 COUNTER TOP. 48.25"W x 21"D x 81"H



E1136-48 TWO E1112 LOWER CABINETS & TWO E1117 UPPER CABINETS W/ E1121-48 BACKSPLASH AND E1120-48 COUNTER TOP. 48.25"W x 21"D x 81"H



E1137-72 E1112, E1113 & E1114 LOWER CABINETS, TWO E1119 UPPER CABINETS, E1118 UPPER CABINET, E1128 SINK, E1121-72 BACKSPLASH AND E1120-72 COUNTER TOP. 72.25"W x 21"D x 81"H



E1138P-72 E1111P, E1112P & E1113P LOWER CABINETS, TWO E1117 UPPER CABINETS, E1118 UPPER CABINET, E1128 SINK, E1121-72 BACKSPLASH AND E1120-72 COUNTER TOP. 72.25"W x 21"D x 81"H

RECEPTION



Nico

E1165P-60 NICO RECEPTION DESK W/ ACCENT LED LIGHTS, METAL ACCENT TOE-KICK FOUR DOORS & ADJUSTABLE SHELVES. 60"W x 24"D x 39"H



E1165-60 NICO RECEPTION DESK W/ ACCENT LED LIGHTS, FOUR DOORS & ADJUSTABLE SHELVES. 60"W x 24"D x 39"H



Nico

E1165P-36 NICO RECEPTION DESK W/ ACCENT LED LIGHTS, METAL ACCENT TOE-KICK TWO DOORS & ADJUSTABLE SHELVES. 36"W x 24"D x 39"H



E1165-36 NICO RECEPTION DESK W/ ACCENT LED LIGHTS, TWO DOORS & ADJUSTABLE SHELVES. 36"W x 24"D x 39"H

Aspen



E1162 FINLEY RECEPTION DESK WITH WRAP AROUND LEDGE, TWO DOORS & ADJUSTABLE SHELVES. 42"W x 28"D x 42"H

Finley

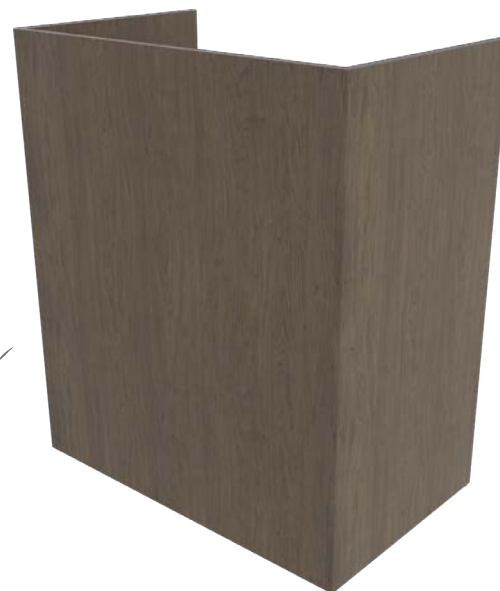

E1161 FINLEY RECEPTION DESK TWO DOORS & ADJUSTABLE SHELVES. 36"W x 22"D x 42"H



E1164 ASPEN RECEPTION DESK W/ METAL LEGS, CHECK LEDGE TWO DOORS & ADJUSTABLE SHELVES. 36"W x 22"D x 42"H



E1163 ASPEN APPOINTMENT DESK W/ METAL LEGS, TWO DOORS & ADJUSTABLE SHELVES. 36"W x 22"D x 36"H

RECEPTION

Brixen



E280-24 BRIXEN RECEPTION CHAIR
27.5"W x 25"D x 34"H



E280-48 BRIXEN RECEPTION LOVE SEAT
55"W x 25"D x 34"H



E1173 FLOATING SHELF RETAIL WITH LOWER STORAGE. 24"W x 13.5"D x 84"H



E1171 FINLEY RETAIL DISPLAY WITH GLASS SHELVES. 29.5"W x 16"D x 80"H



E1172 NICO STACKED RETAIL WITH LOWER STORAGE.

Lila



E380-24 LILA RECEPTION CHAIR
24.5"W x 26.5"D x 34"H



E380-48 LILA RECEPTION LOVE SEAT
52"W x 26.5"D x 34"H



E1174-18 3 FLOATING RETAIL SHELVES
18"W x 8"D x 2"H



E1174-36 3 FLOATING RETAIL SHELVES
36"W x 8"D x 2"H



E1172P NICO STACKED RETAIL WITH LOWER STORAGE AND ACCENT METAL TOE-KICK

Upholstery Selections



FLAT BLACK SADDLE CHAMPAGNE

MANICURE & PEDICURE



E1151 ESSENTIALS PETITE NAIL TABLE W/ DRAWER, CASTERS, LAMP AND PADDED REST. 31"W x 15.5"D x 31"H



E1152 ESSENTIALS NAIL TABLE W/ DRAWERS, DOOR, CASTERS, LAMP AND PADDED REST. 42"W x 15.5"D x 31"H
PICTURED WITH LILA E340 CLIENT CHAIR AND E360 STOOL



E1153 ESSENTIALS TALL NAIL TABLE W/ TWO DRAWERS, ONE DOOR, CASTERS, LAMP AND PADDED REST. 42"W x 15.5"D x 31-37"H



STANDARD VENTED OPTION
MODEL NUMBERS (PICTURED ABOVE)
E1151P - E1152P - E1153P

10633 VALENTINO POWERED VENT W/ CHARCOAL FILTER ALSO AVAILABLE

Optional Vent available on all models



E240 BRIXEN TASK-CLIENT CHAIR
27.5"W x 25"D x 31"H



E140 MERANO TASK-CLIENT CHAIR
26"W x 26"D x 30.5"H



E160 MERANO STOOL
20"W x 26"D x 28.5"H



E340 LILA TASK-CLIENT CHAIR
24.5"W x 26.5"D x 31"H



E360 LILA STOOL
18.5"W x 26.5"D x 29"H



E271 OTTOMAN ON CASTERS
16"W x 16"D x 16"H



E272 PRO FOOT BASIN W/ HEAT, MASSAGE & DISPOSABLE LINERS. 11.5"W x 14"D x 9"H

E270 BRIXEN CLUB PEDI W/ HIDE-AWAY PRO FOOT BASIN. 27"W x 28"D x 37"H



Upholstery Selections



FLAT BLACK SADDLE CHAMPAGNE

MEN'S GROOMING



WET STATIONS ON PAGES 22 & 23

8013.W VEECO TRIBUTE BARBER CHAIR
(WHITE METAL ACCENTS)
27.5"W x 52"D x 43"H

8071 SAMSON RECLINING BARBER CHAIR
(8071S STATIONARY ALSO AVAILABLE W/ NO
HEADREST) 29"W x 35"D x 36"H

8013.B VEECO TRIBUTE BARBER CHAIR
(BLACK METAL ACCENTS)
27.5"W x 52"D x 43"H

707.B JEFFCO JAGUAR BARBER CHAIR
(BLACK ONLY) 27"W x 43"D x 44"H

8088.B-A BRUSHED PRINCETON BARBER
CHAIR (8088 CHROME FRAME ALSO
AVAILABLE) 25"W x 44"D x 42"H

Upholstery Selections



FLAT BLACK SADDLE CHAMPAGNE



E1071 FINLEY BARBER STATION W/ FOUR CLIPPER
HOOKS, TWO DUPLEX OUTLETS, TWO DOORS WITH
ADJUSTABLE SHELF, BARBER TOOL PANEL & TWO
BARBICIDE HOLDERS. 58+6"W x 15.5"D x 39"H



E1071P W/ FOUR CLIPPER HOOKS, TWO DUPLEX
OUTLETS, TWO DOORS WITH ADJUSTABLE SHELF,
BARBER TOOL PANEL, SIX OUTLET POWER STRIP &
TWO BARBICIDE HOLDERS. 58+6"W x 15.5"D x 39"H



E1072P ASPEN BARBER STATION ON METAL LEGS W/
FOUR CLIPPER HOOKS, TWO DUPLEX OUTLETS, ONE
DOOR WITH ADJUSTABLE SHELF, BARBER TOOL
PANEL DRAWER WITH SIX OUTLET POWER STRIP AND
TWO BARBICIDE HOLDERS. 64"W x 15.5"D x 39"H

Aspen



E1072 ASPEN FLOATING BARBER STATION W/ FOUR CLIPPER
HOOKS, TWO DUPLEX OUTLETS, ONE DOOR WITH ADJUSTABLE
SHELF, BARBER TOOL PANEL DRAWER WITH SIX OUTLET POWER
STRIP AND TWO BARBICIDE HOLDERS. 64"W x 15.5"D x 33"H



E1073 NICO BARBER STATION W/ FOUR
CLIPPER HOOKS, TWO DUPLEX OUTLETS,
ONE DOOR WITH ADJUSTABLE SHELF, TIP-OUT
BARBER TOOL PANEL WITH SIX
OUTLET POWER STRIP AND TWO BARBICIDE
HOLDERS. 60"W x 15.5"D x 42"H



E1073P NICO BARBER STATION W/ ACCENT
METAL TOE KICK FOUR CLIPPER HOOKS, TWO
DUPLEX OUTLETS, ONE DOOR WITH ADJUSTABLE
SHELF, TIP-OUT BARBER TOOL PANEL WITH SIX
OUTLET POWER STRIP AND TWO BARBICIDE
HOLDERS. 60"W x 15.5"D x 42"H

Nico

BOWLS & PARTS



CB79-B COMFORT-PAD PORCELAIN BOWL
24.5"W x 22"D x 10"H
UPC APPROVED - FEATURING HEAD PAD FOR CLIENT COMFORT, A 570 FAUCET, SPRAY HOSE, VACUUM BREAKER, DRAIN ASSEMBLY, HAIR STRAINER - (ALSO AVAILABLE IN WHITE)



CB86-W PORCELAIN TILTING BOWL
20"W x 22"D x 11.5"H
UPC APPROVED - FEATURING A TILT MECHANISM, 570 FAUCET, SPRAY HOSE, VACUUM BREAKER, DRAIN ASSEMBLY, HAIR STRAINER, FLEXIBLE TAIL STOCK - BEST ALL AROUND BACKWASH TILT BOWL (ALSO AVAILABLE IN BLACK)

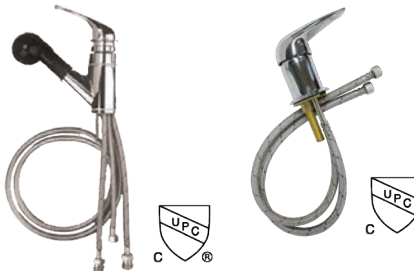

800 800 FAUCET COLLINS 800 FAUCET WITH BUILT-IN VACUUM BREAKER. (WI APPROVED).
570 570 FAUCET JEFFCO METAL SINGLE HANDLE FAUCET, UPC APPROVED.



5B-1 HAIR STRAINER NOT UNIVERSAL
572 HAIR STRAINER ASSY 3 1/2" STRAINER BASKET ASSEMBLY, FITS MOST BOWLS.



563 HOSE RECEIVER UNIVERSAL HOSE RECEIVER PLATE, FITS MOST BOWLS.
400 DIVERTER SPOUT FITS ANY BOWL.



CB19.532.VB STANDARD ABS BOWL
19"W x 19.5"D x 10"H
UPC APPROVED - FEATURING A 532 METAL SINGLE HANDLE FAUCET, SPRAY HOSE, VACUUM BREAKER, DRAIN ASSEMBLY, HAIR STRAINER, AND MOUNTING BRACKET.



CB80-W SQUARE PORCELAIN BOWL
19"W x 20"D x 10"H
UPC APPROVED - FEATURING A 570 FAUCET, SPRAY HOSE, VACUUM BREAKER, DRAIN ASSEMBLY, HAIR STRAINER, AND MOUNTING BRACKET - (ALSO AVAILABLE IN BLACK)



CB85-W SHALLOW PORCELAIN TILTING BOWL
19"W x 24"D x 9.5"H
UPC APPROVED - FEATURING A TILT MECHANISM, 570 FAUCET, SPRAY HOSE, VACUUM BREAKER, DRAIN ASSEMBLY, HAIR STRAINER, AND FLEXIBLE TAIL STOCK (ALSO AVAILABLE IN BLACK AND NON-TILTING DECK-MOUNTED)

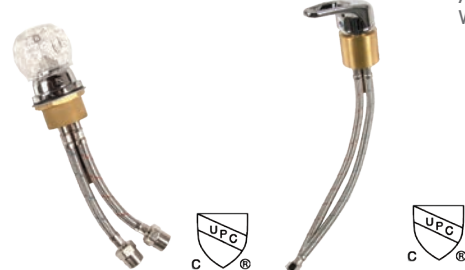

552 552 FAUCET HANDLE FAUCET WITH ACRYLIC KNOB, UPC APPROVED. DELTA REPLACEMENT
532 532 FAUCET COLLINS METAL SINGLE HANDLE LOW PROFILE FAUCET, UPC APPROVED.



H1-T QUICK CLEAN HAIR TRAP
1701 HAIR TRAP MOLDED PLASTIC CATCH-ALL HAIR TRAP



CB23.532.VB LARGE ABS BOWL
23"W x 20"D x 11"H



CB81-B HEART-SHAPED PORCELAIN BOWL
23"W x 20"D x 10"H
UPC APPROVED - FEATURING A 570 FAUCET, SPRAY HOSE, VACUUM BREAKER, DRAIN ASSEMBLY, HAIR STRAINER, AND MOUNTING BRACKET - (ALSO AVAILABLE IN WHITE)



CB82-B ROUND PORCELAIN TILTING BOWL
23.5"W x 21.5"D x 9"H
UPC APPROVED - FEATURING A TILT MECHANISM, 570 FAUCET, SPRAY HOSE, VACUUM BREAKER, DRAIN ASSEMBLY, HAIR STRAINER, FLEXIBLE TAIL STOCK - BEST ALL AROUND SIDE WASH TILTING BOWL (ALSO AVAILABLE IN WHITE)



388-VB VACUUM BREAKER KIT COMPLETE VACUUM BREAKER KIT, COMPLETE WITH ALL NEEDED PARTS. FITS ANY BOWL.



561 SPRAY HOSE
581 SPRAY HOSE. ALLOWS HAND WASHING AT SHAMPOO BOWL



660NR GEL NECK REST FITS MOST BOWLS

DRYERS & PROCESSORS



2200 COLLINS SOL-AIR DRYER
12.5"W X 6.5"D X 23.75"H CABINET • FEATURING IONIC TECHNOLOGY, NEGATIVE ION GENERATOR, DIGITAL-EXACT TEMPERATURE CONTROL, DIGITAL-EXACT TIMER, SMOKED HOOD, 110 VOLTS, 1400 WATTS, AND 13 AMPS.
K500 JEFFCO APOLLO HAIR DRYER
12.5"W X 6.5"D X 23.75"H CABINET • FEATURING DIGITAL CONTROLS, TEMPERATURE REACHING 150 DEGREES F, SMOKED HOOD, 110 VOLTS, 1400 WATTS, AND 13 AMPS.

WA-300 DRYER WHEEL KIT
RAISES DRYER 8.5" OFF GROUND • FEATURING LARGE WHEELS AND STEEL FRAME FOR USE WITH SOL-AIR OR APOLLO MODELS



3524H VEECO ARISTETTE II WALL MOUNTED DRYER
WALL MOUNTED VERSION OF 3524S WITH ARTICULATING WALL-MOUNTED ARM W/ 5'4" DIAMETER REACH



3524S VEECO ARISTETTE II STAND DRYER
26"W X 20"D X 65"H • FEATURING A DOWN-DRAFT DRYER W/ DIGITAL CONTROLS, ION GENERATOR, COOL-DOWN CYCLE - HOOD MEASURES 12.5" INSIDE DIAMETER, 110 VOLTS, 1000 WATTS



1433H TEMPTURA ULTRA WALL MOUNTED DRYER
WALL MOUNTED VERSION OF 1433S - WITH ARTICULATING WALL-MOUNTED ARM W/ 5'4" DIAMETER REACH
1433S TEMPTURA ULTRA STAND DRYER
26"W X 20"D X 65"H • FEATURING A DOWN-DRAFT DRYER W/ SMOKED HOOD, VARIABLE TIME AND TEMPERATURE SETTINGS, COOL-DOWN CYCLE - HOOD MEASURES 12.5" INSIDE DIAMETER, 17.5" DIAMETER AT LARGEST POINT, 110 VOLTS, 1000 WATTS
1487S QUANTUM STAND PROCESSOR
26"W X 20"D X 65"H • FEATURING FAR-INFRARED TECHNOLOGY, DIGITAL CONTROLS, OVER-SIZED NON-TIPPING BASE, 110 VOLTS, AND 1300 WATTS. WALL-MOUNTED VERSION P/N 1487H



1464S GALAXY ORBITAL STAND PROCESSOR
26"W X 20"D X 65"H • FEATURING FAR-INFRARED TECHNOLOGY, DIGITAL CONTROLS, OVER-SIZED NON-TIPPING BASE, 110 VOLTS, AND 900 WATTS.



1487H QUANTUM WALL MOUNTED PROCESSOR
WALL MOUNTED VERSION OF 11487S WITH ARTICULATING WALL-MOUNTED ARM W/ 5'4" DIAMETER REACH



1464H GALAXY ORBITAL WALL MOUNTED PROCESSOR
WALL MOUNTED VERSION OF 1464S WITH ARTICULATING WALL-MOUNTED ARM W/ 5'4" DIAMETER REACH

BASES & FOOTRESTS

5 YEAR WARRANTY



10268C 1" TUBULAR STEEL U-SHAPED FOOTREST

10802 TUBULAR STEEL T-BAR FOOTREST WITH CAST ALUMINUM FOOT-PLATE



-4250

-4250BB

-3250S

-5250

-4250V

-4250DD

-4250DS

7 1/2 YEAR WARRANTY

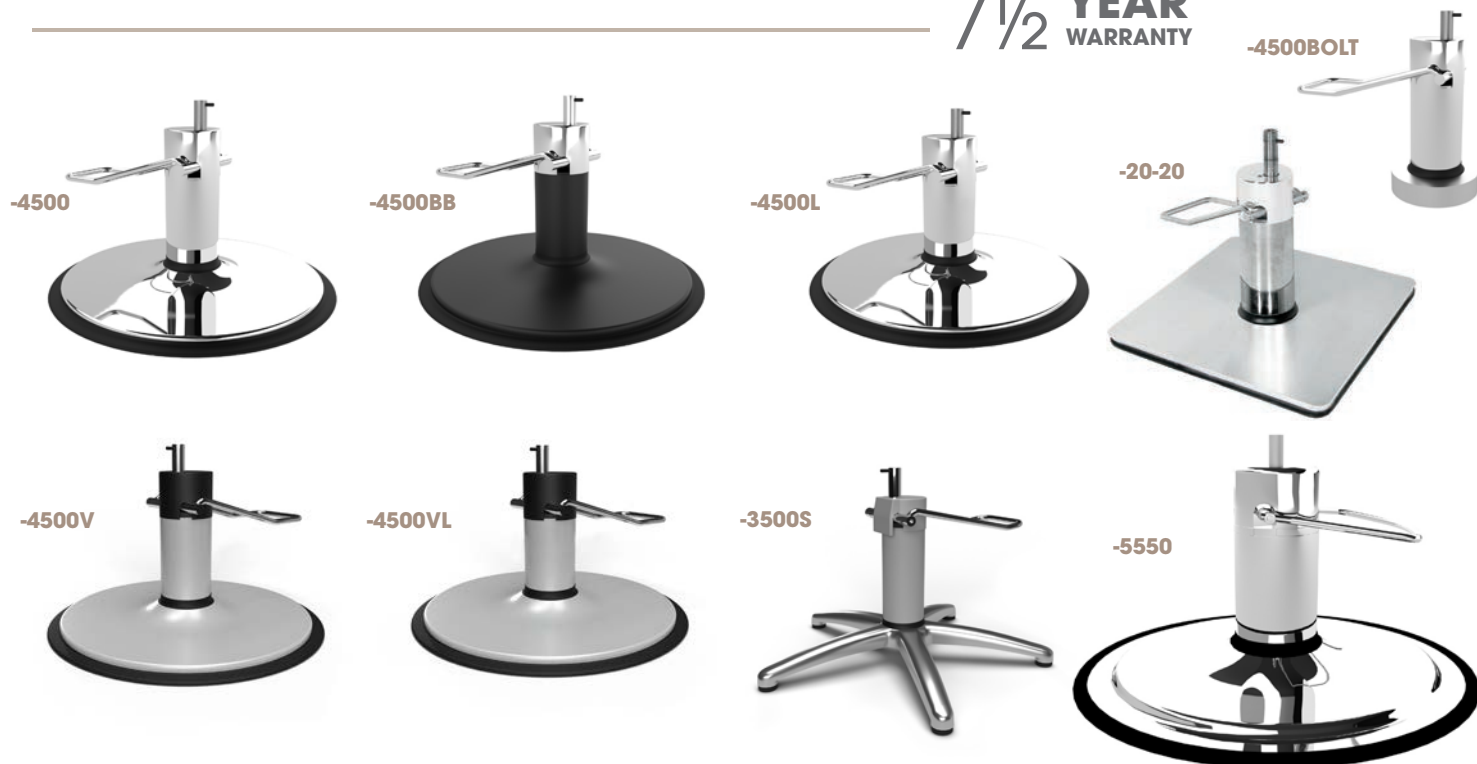

-4500

-4500BB

-4500L

-20-20

-4500BOLT

-4500V

-4500VL

-3500S

-5550

MATS



THE COLLINS COMFORT ZONE SALON MAT IS A MOLDED URETHANE MAT W/ CHAIR BASE DEPRESSION.

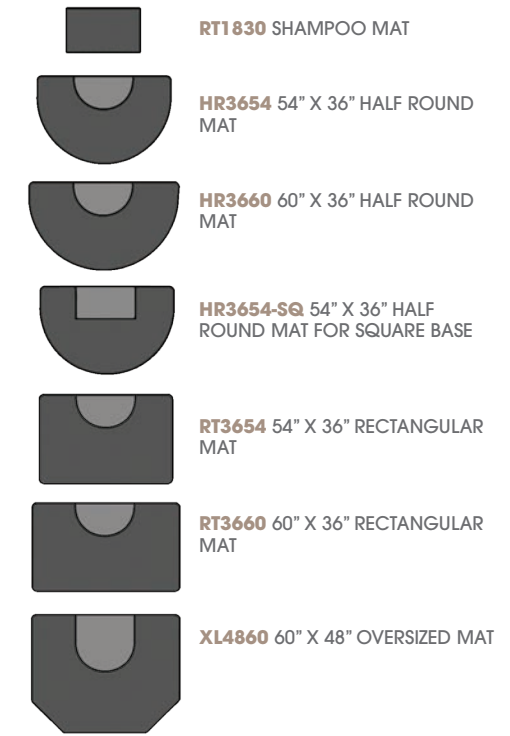

RT1830 SHAMPOO MAT

HR3654 54" X 36" HALF ROUND MAT

HR3660 60" X 36" HALF ROUND MAT

HR3654-SQ 54" X 36" HALF ROUND MAT FOR SQUARE BASE

RT3654 54" X 36" RECTANGULAR MAT

RT3660 60" X 36" RECTANGULAR MAT

XL4860 60" X 48" OVERSIZED MAT

WARRANTY

COLLINS WARRANTIES

Collins has an extensive and comprehensive warranty policy. The following are the terms of warranties on various components:

7.5 Years: All USA made foot operated hydraulic bases | 5 years: Collins Comfort Zone anti-fatigue mats, Collins ABS shampoo bowls, Import 3250/4250/5250 hydraulic base, Sol-Air dryer motors and hoods, All-purpose and shampoo chair back reclining mechanisms | 3 years: Molded urethane arms, All cabinet drawer slide, hinges | 2 Years: Jeffco Apollo dryer motors and hoods, All Collins-Jeffco faucets | 1 year: All remaining components, unless otherwise noted

Warranty policies: These warranties cover replacement/repair parts and shipping of the replacement/repair parts within the contiguous U.S. Not labor. These warranties do not cover wear and tear or damage caused by water, fire, staining, fading, or discoloration of fabrics, laminates, or finishes, or where there is evidence of tampering, mishandling, abuse, or misuse of the equipment. Warranty is also void if customer is not the original purchaser of the equipment.

For complete warranty and policy information www.collins.co/warranty

PROPOSITION 65 WARNING INFORMATION

CABINETRY
"This product can expose you to chemicals including wood dust, which is known to the State of California to cause cancer. For more information go to www.P65Warnings.ca.gov/furniture."

SEATING
"This product can expose you to chemicals including diisononyl phthalate (DINP), which is known to the State of California to cause cancer or birth defects or other reproductive harm. For more information go to www.P65Warnings.ca.gov/furniture."

PORCELAIN
"This product can expose you to chemicals including Titanium Dioxide, which is known to the State of California to cause cancer. For more information go to www.P65Warnings.ca.gov/furniture."



collins

www.collins.co



#MADEFORMEBYCOLLINS